

MIXERS FOR

WATER & WASTEWATER TREATMENT



www.mixtec-europe.com

MIXTEC
FOR MIXING TECHNOLOGY



MIXTEC

FOR MIXING TECHNOLOGY

CUSTOM DESIGNED MIXERS

The Mixtec group designs and manufactures a broad spectrum of specialized, custom-designed mixing equipment for the water and wastewater treatment industries. Our mixers are employed in municipal installations and projects throughout the world. Mixtec offers a well-built mixer for both potable water and wastewater treatment needs such as rapid mixing, flocculation, anoxic and anaerobic mixing.

Our ability to solve mixing problems with the latest technology and expertise is due to our highly trained design engineers and commitment to mixing research and development.

We aim to always improve the performance and efficiency of our mixers ensuring increased productivity, operational life, and cost savings. We also offer retrofitting and refurbishment of existing mixers through our full technical and maintenance support via our after-sales services. It is our priority to ensure we are available for site visits, installation inspections, and hot/cold commissioning services. We pride ourselves on high quality, reliable designs, and manufacturing capabilities.



Mixtec Offerings:

- Custom designed impeller technology.
- CFD and FEA analysis.
- Wet ends constructed in suitable corrosion resistant materials including Stainless Steel and High alloy SS.
- Low Operational costs resulting in low life cycle cost.
- Raised baseplates to allow access to the drive coupling during installation & maintenance.
- Carbon steel hot dipped galvanised raised baseplates.
- Epoxy coated carbon steel wet ends.

THE MIXTEC SERIES OF MIXERS



250 Series
/Direct
Drive



1000
Series



2000
Series



4000
Series

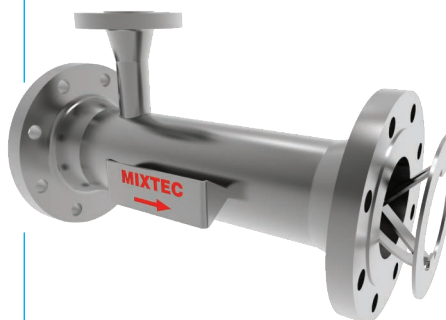

Static
Mixer

WATER TREATMENT IMPELLERS

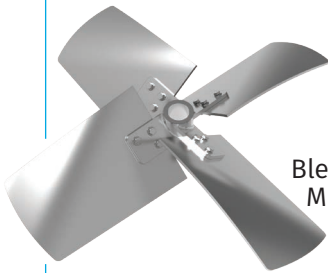

HA710

Blending of Low to Medium Viscosity Products & Dissolving

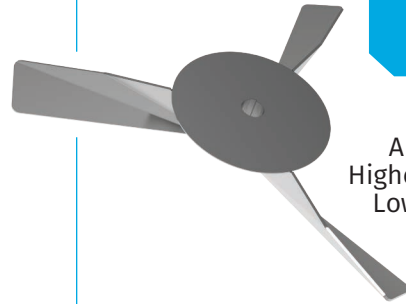

AS700

Anti-snagging Higher Efficiency, Low Shear Axial / Radial Flow

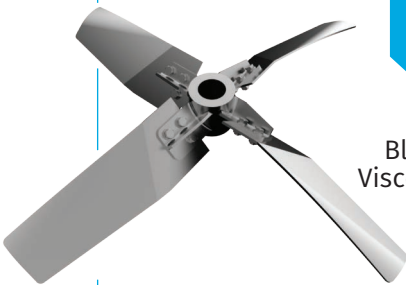

HA724

Blending of Low Viscosity Products & Dissolving

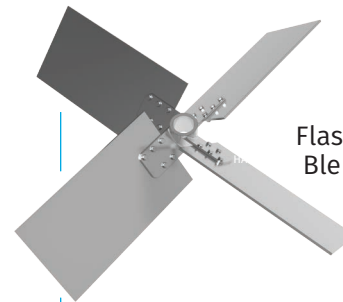

HA475

Flash/Rapid Mixing - Blending of Medium to High Viscosity Products & Dissolving.

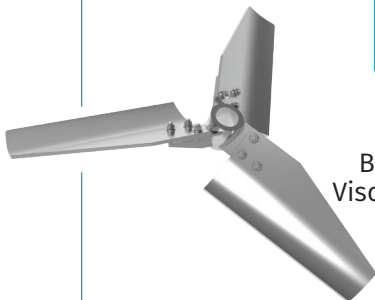

HA800

Blending of Low Viscosity Products & Dissolving



HA794

Anti-snagging Radial Flow Blending of Low Viscosity Products & Dissolving

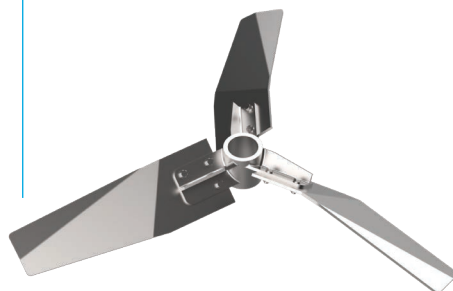

HA715/
HA720

Strong Axial Flow - Low to Medium Viscosity Blending & Solids Suspension.

CATEGORIES IN WATER TREATMENT

1. POTABLE WATER

1 CHEMICAL MAKE-UP



- For applications such as lime and aluminium sulphate, our standardised HA715 or HA720 impellers are recommended.
- These three-bladed, high efficiency axial down pumping impellers, are best suited for blending applications.
- Our HA724, four-bladed axial down pumping impeller is also recommended for a more aggressive blend.
- These impellers are designed for low shear, high flow applications.

Capabilities

- Our impellers have strong axial flows that allow for sufficient off-bottom spacing to ensure the impeller does not become trapped in settled solids during process shutdowns.
- These impellers host many advantages including greatly reducing gearbox shaft stresses, higher flow for lower wear rates and improves handling capabilities.
- Our polymer mixers are specialised to account for variations such as forms, concentrations and viscosities
- We understand and can design for the varying mixing intensities requiring different chemicals.
- Our most common choice for a potable water process, is 304 or 316 stainless steel.

CATEGORIES IN WATER TREATMENT

1. POTABLE WATER

2 FLASH / RAPID MIXING

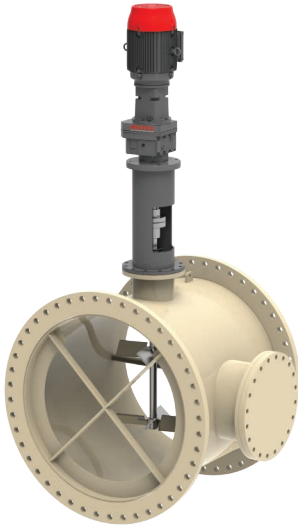

- Rapid blending process used to disperse and blend chemicals into water streams.
- For this type of application our HA720, HA724 and HA745 impellers are used.
- In the mixer design, we consider the G-value and very high tip speeds.
- If the G-Value is unknown, it can be calculated using the required retention time.
- Our Instamix allows for in situ mixing of fluids – can be installed in existing pipework.

3 FLOCCULATION

Flocculation is a highly shear sensitive mixing application. Unlike most mixing applications, a flocculators function is to simply maintain the water in motion. It allows the agglomeration of the particles to proceed

Our HA715 and HA800 impellers have been developed and refined to:

- Operate at low tip speeds to maintain low shear and turbulence
- Generate high axial flow

We are involved in the sanitation process and are aware of chemicals that are used in the process. If the concentration of calcium hypochlorite is high in the solution, then the wet ends are made of carbon steel. They are lined with a fluoropolymer. Most of our wet ends are made of 304 or 316 stainless steel.



CATEGORIES IN WATER TREATMENT

2. WASTEWATER TREATMENT

In many water treatment processes, you require precise mixing control at every stage, from rapid mixing to polymer addition. While some chemicals simply need to be dissolved, others—such as lime slurries—require special attention to the solids, mass transfer and reactions in the neutralization stage in your process.

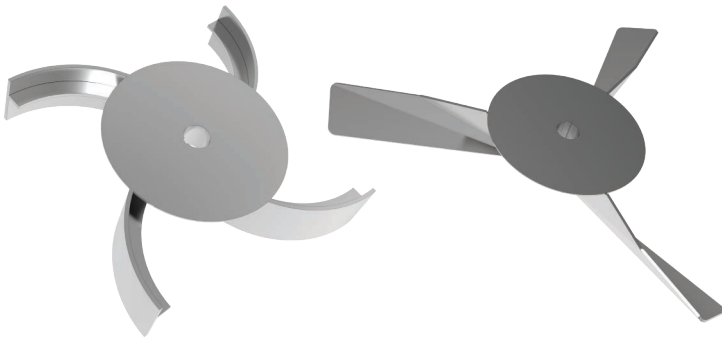

1 ANTI RAGGING IMPELLERS



Mixtec's AS700 combined axial down and radial flow impeller is specifically designed for wastewater treatment applications

- Features a unique anti-snagging geometry to avoid harmful rag entanglement.
 - For smaller fully welded impellers, our backswept blades and a 'bolt-free' one-piece design gives anti-fouling properties with much lower power draw than the HA794 due to hydrofoil style blades.
 - Larger impellers use a counter-sunk bolt through the keeper plate to secure the impeller to the shaft.
- The combined axial and radial flow generated by this impeller gives effective floor scouring.
 - AS700 is a high efficiency axial and radial Hydrofoil impeller developed specifically for duties where ragging risk is present.
 - The disc also helps with reducing fouling around the shaft and hub— the best choice for wastewater applications such as anoxic/anaerobic chambers.

2. WASTEWATER TREATMENT

2 ANOXIC AND ANAEROBIC (BNR)

Mixtec's effective HA794 and AS700 anoxic and anaerobic design promotes denitrification by combining nitrates and organic microbiological material. Nitrogen and phosphorus are the primary cause of eutrophication resulting in algal blooms, low dissolved oxygen and endangerment to aquatic life. Anaerobic digester mixers are used to stabilize sludge, through the decomposition of organic and inorganic matter in the absence of oxygen.

Our mixers are designed to:

- Homogenize solids in distribution throughout a basin using low shear, high flow pumping action.
- Provide uniform suspension to prevent separation of grit and other inert to reduce dead zones and sludge build up.
- Improve treatment efficiency by increasing contact between raw sludge and bacteria without damaging bacterial growth.
- Prevent the development of scum layer by gently breaking up and drawing floatable organics into the process.
- Eliminate the introduction of air from liquid surface with our anti-vortexing plate.



INLINE STATIC MIXER (INSTAMIX)

Having no moving parts, an Inline static mixer uses the energy developed from the pressure drop over the mixer elements and inner pipe walls to mix the product to a specified degree by splitting, re-combining and spinning the flow. Mixtec's unique element design, backed by CFD design and testing, provides a better overall mix for the same pressure drop.

ADVANTAGES:

- Simple and consistent mixing
- Easy to install in existing pipelines.
- Low in capital and maintenance costs.
- A high degree of homogeneity can be achieved in a very short length of pipe.
- Easy injection nozzles for in situ dosing



Materials of Constructions

Mixtec manufactures its INSTAMIX range from materials such as, 304 / 316 / 904L Stainless steel, Hastelloys, Alloy 2205 & 2507 and Titanium, amongst others. In order to make our static mixers more cost effective, we also offer a range of coatings that can be applied to the mixer internals to make them more chemical resistant without the added cost of manufacturing the entire mixer from expensive steels. Our coatings include: Epoxy, Rubber Lining, Halar & Ultralar (ECTFE), Fiberglass, PTFE line Stainless Steel.

Flange Options

Compatible with industry standard injection quills for controlled dosing of chemicals into the main stream. All static mixers can be made to suit client requirements using all available flange types and specifications or, can included male or female threaded ends on both the main stream or inlet nozzles.

Sizing

Each Static Mixer is custom designed specifically to suit your application, with the option of having multiple injection points along the body of the mixer. Sizes from as small as 15NB up to, and exceeding, 2.1 m (+-7ft) in diameter we are confident we can provide a solution to suit your needs.

RESEARCH AND DEVELOPMENT

Mixtec believes in constant innovation. Our on-site laboratory, fluid handling facilities and experienced research engineers allow us to find the optimum design for specific water treatment needs. With in-depth knowledge of varying fluid behaviours, we ensure that we maximize our clients process results.

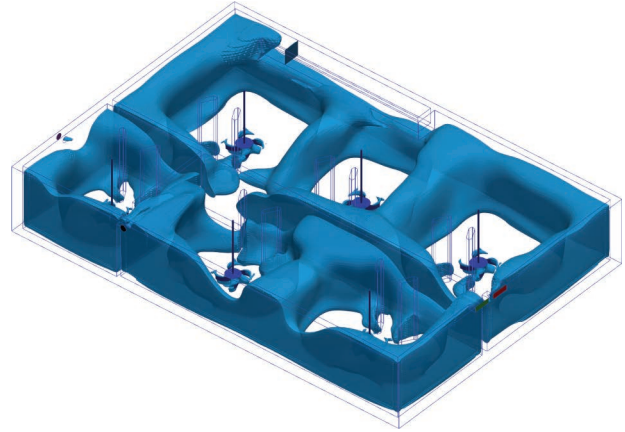
**COMPUTATIONAL FLUID DYNAMICS (CFD)**

- We can advise on optimum tank design and special arrangements, such as anti-vortex baffles, risers, dip tubes, mounting structures, nozzle orientations and the most economical vessel shape.
- With our CFD, 3D modelling software we ensure enhanced efficiency and product reliability.
- CFD analysis allows us to understand flow characteristics generated by our impellers - enabling us to virtually assess mixer performance under a variety of conditions to aid the development of improved impeller design.
- For new mixing technology or highly specialised solutions, we can produce a scaled model for trials in our laboratory.
- Our R&D team performs required test work to verify simulation results – ensuring higher customer confidence for their plant.
- CFD analysis allows us to analyze more scientifically to challenge preconceptions eg, w/m³ and allows for better, more confident performance predictions.

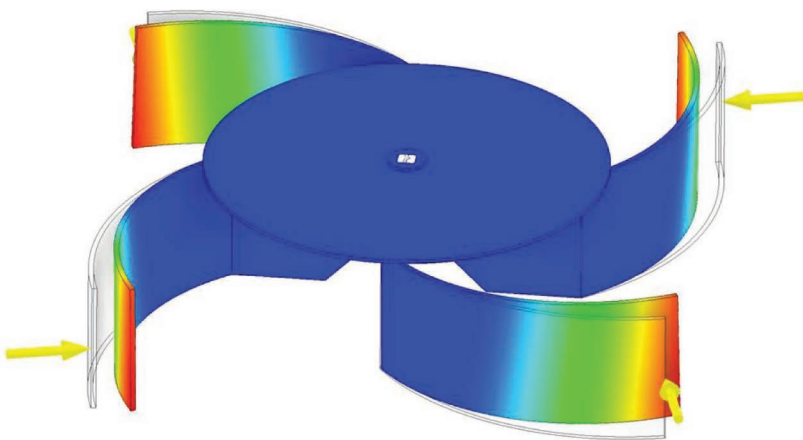
**FINITE ELEMENT ANALYSIS (FEA)**

FEA Analysis refines and strengthens designs to ensure longevity and custom designed solutions for customer specific problems. We often design non-standard parts and equipment to suit our client's application requirements.

FEA is used to:

- Reduce material costs.
- Increase strength.
- Ensure designs have sufficient life.

ENGINEERING

Along with our robust and economical design technology, we also work closely with many of the world's leading gearbox manufacturers that design drives specifically for agitator duties. The selection of a gearbox and motor is of the utmost importance. We offer a variety of extra features including, anti-condensation heaters and thermistors, and can also be supplied according to a set specification.

- The design considers a drop-spread bearing to handle higher overhung loads, drywell for positive notice of oil leakage before reaching the water and inclusion of food-grade oil – which is a standard on all Mixtec municipal and wastewater applications.
- Agitator drives are selected to withstand the static and dynamic loads.
- Bearing life calculations are performed to ensure an adequate bearing life is achieved.
- Have been actively retrofitting existing mixer drives with the latest wet-end technology – by replacing blades and refurbishing shafts and couplings, resulting in lighter loads on gearboxes.
- Raised baseplates are the preferred mounting arrangement – as the coupling is accessible and allows for easy draining of gearbox oil.



QUALITY ASSURANCE



- We aim to conduct all business activities - sensibly and professionally - seeking continuous improvement and compliance to all legal and other requirements.
- Manufactured under strictest conditions to the highest standards to suit intended operating environments - ensuring maximum productivity and minimum power draw.
- Components undergo various testing such as non-destructive testing, magnetic particle and ultra-sonics according to client requirements.
- Ensure compliance with procedures such as impeller balancing, directional flow and impeller rotation of our wet ends.
- Our commissioning engineers are available to ensure installations and correct procedures are in place for new equipment.

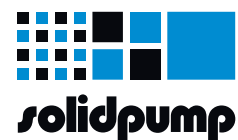

Exclusive Mixtec agent in Europe
excluding UK and France
Solidpump Europe SIA
Uriekstes iela 14a, Rīga,
LV-1005, LATVIA

info@mixtec-europe.com
info@solidpump.com
+371 6696 8996

www.mixtec-europe.com

MIXTEC
FOR MIXING TECHNOLOGY